

**Features:**

- Wide Capacitance range 10nF to 4700nF
- High contact reliability
- Easy to install.

**Applications:**

- Broadband interference suppression for shielded rooms
- Telephone exchanges, base stations
- Electrical machines and systems.

**Performance Indicator:**

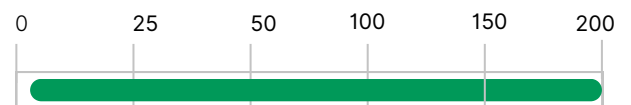
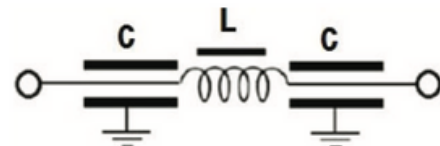
**Rated Current (A):**

**Type Circuit Diagram:**

**DATASHEET**
**FEEDTHROUGH FILTERS-FTFAC**

Feedthrough filter Provide high attenuation across broad frequency range, extending up to 1 GHz. they are available in wide selection of capacitance values and are offered with diverse Mounting configurations and Termination options to suit various application Requirement .

**Technical Specifications:**

|                                      |  |
|--------------------------------------|--|
| Maximum Continuous Operating Voltage | :250 VAC                                   |
| Operating Frequency                  | :50/60 Hz                                  |
| Current ratings                      | :6 A to 200 A @60° C                       |
| High Potential test voltage          | :3000 VDC Line to Case For 2 sec           |
| Capacitance Class                    | :Y2  |
| Design Corresponding to              | :UL 60939-3, IEC 60939-1&2, CSA C22.2 No.8 |
| Flammability corresponding to        | :UL 94 V-1 or Better                       |
| Temperature range                    | :-40°C to +100°C                           |
| Climatic Category                    | :40/100/21                                 |

## Ordering Information

| Model Number     | Part Number | Current Rating @60°C(A) | Leakage Current @250 VAC/50Hz (mA) | Capacitance (nF) ±20% | Min.Weight (kg) |
|------------------|-------------|-------------------------|------------------------------------|-----------------------|-----------------|
| FTFAC-0010N-010A | E106685-1   | 10                      | 2                                  | 10                    | 0.4             |
| FTFAC-0022N-016A | E106686-1   | 16                      | 4.5                                | 22                    | 0.5             |
| FTFAC-0022N-032A | E106687-1   | 32                      | 4.5                                | 22                    | 0.5             |
| FTFAC-0047N-010A | E106688-1   | 10                      | 10                                 | 47                    | 0.5             |
| FTFAC-0100N-016A | E106689-1   | 16                      | 20                                 | 100                   | 0.5             |
| FTFAC-0100N-032A | E106690-1   | 32                      | 20                                 | 100                   | 0.5             |
| FTFAC-0100N-075A | E106691-1   | 75                      | 20                                 | 100                   | 0.8             |
| FTFAC-0150N-063A | E109822-1   | 63                      | 32                                 | 150                   | 0.8             |
| FTFAC-0220N-130A | E112666-1   | 130                     | 50                                 | 220                   | 0.7             |
| FTFAC-0470N-010A | E110090-1   | 10                      | 90                                 | 470                   | 1.0             |
| FTFAC-0470N-016A | E110091-1   | 16                      | 90                                 | 470                   | 1.5             |
| FTFAC-0470N-025A | E106692-1   | 25                      | 90                                 | 470                   | 1.5             |
| FTFAC-0470N-032A | E110092-1   | 32                      | 90                                 | 470                   | 1.5             |
| FTFAC-0470N-063A | E106693-1   | 63                      | 90                                 | 470                   | 2.0             |
| FTFAC-0470N-075A | E106694-1   | 75                      | 90                                 | 470                   | 2.0             |
| FTFAC-0470N-100A | E106695-1   | 100                     | 90                                 | 470                   | 2.0             |
| FTFAC-0470N-130A | E112667-1   | 130                     | 90                                 | 470                   | 0.4             |
| FTFAC-0470N-200A | E106696-1   | 200                     | 90                                 | 470                   | 3.5             |
| FTFAC-1000N-010A | E110093-1   | 10                      | 190                                | 1000                  | 1.5             |
| FTFAC-1000N-016A | E110094-1   | 16                      | 190                                | 1000                  | 1.5             |
| FTFAC-1000N-025A | E106700-1   | 25                      | 190                                | 1000                  | 1.5             |
| FTFAC-1000N-032A | E110095-1   | 32                      | 190                                | 1000                  | 1.5             |
| FTFAC-1000N-063A | E106701-1   | 63                      | 190                                | 1000                  | 3.5             |
| FTFAC-1000N-075A | E106702-1   | 75                      | 190                                | 1000                  | 3.5             |
| FTFAC-1000N-100A | E106703-1   | 100                     | 190                                | 1000                  | 3.5             |
| FTFAC-1000N-200A | E106704-1   | 200                     | 190                                | 1000                  | 3.5             |
| FTFAC-2200N-010A | E110096-1   | 10                      | 420                                | 2200                  | 1.5             |
| FTFAC-2200N-016A | E110097-1   | 16                      | 420                                | 2200                  | 1.5             |
| FTFAC-2200N-032A | E110098-1   | 32                      | 420                                | 2200                  | 3.5             |
| FTFAC-2200N-063A | E106708-1   | 63                      | 420                                | 2200                  | 3.5             |
| FTFAC-2200N-075A | E109823-1   | 75                      | 420                                | 2200                  | 3.5             |
| FTFAC-2200N-100A | E106709-1   | 100                     | 420                                | 2200                  | 3.5             |
| FTFAC-2200N-200A | E106710-1   | 200                     | 420                                | 2200                  | 3.5             |
| FTFAC-3300N-010A | E110099-1   | 10                      | 630                                | 3300                  | 3.5             |
| FTFAC-3300N-016A | E110100-1   | 16                      | 630                                | 3300                  | 3.5             |
| FTFAC-3300N-032A | E110101-1   | 32                      | 630                                | 3300                  | 3.5             |
| FTFAC-3300N-063A | E110102-1   | 63                      | 630                                | 3300                  | 3.5             |
| FTFAC-3300N-100A | E110103-1   | 100                     | 630                                | 3300                  | 3.5             |
| FTFAC-3300N-200A | E110104-1   | 200                     | 630                                | 3300                  | 3.5             |
| FTFAC-4700N-063A | E106714-1   | 63                      | 890                                | 4700                  | 3.5             |
| FTFAC-4700N-100A | E106715-1   | 100                     | 890                                | 4700                  | 3.5             |
| FTFAC-4700N-200A | E106716-1   | 200                     | 890                                | 4700                  | 3.5             |

## Mechanical Information

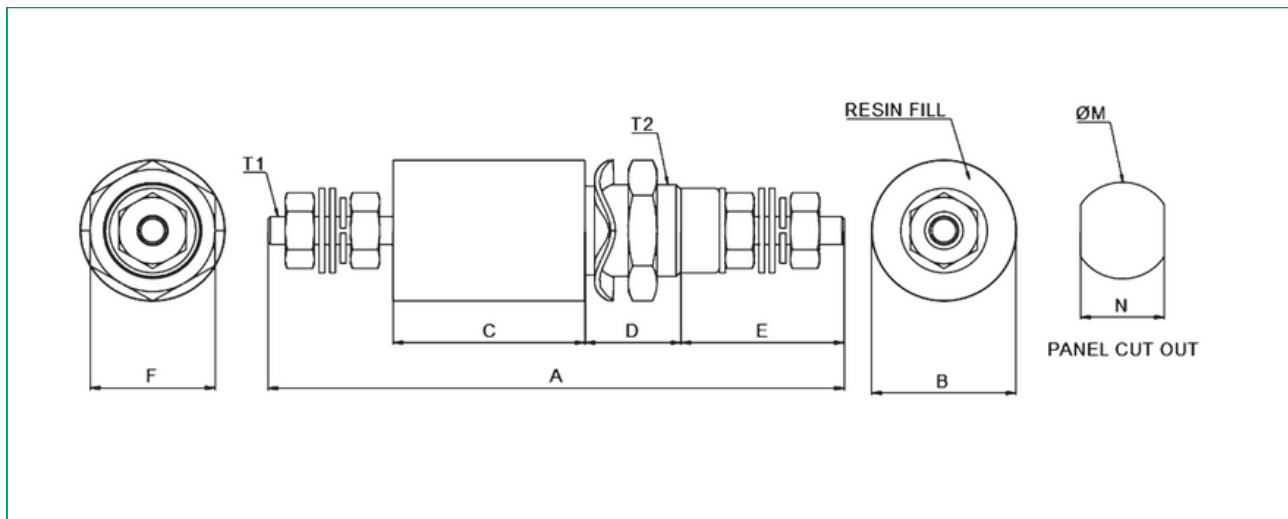

## Mechanical Dimensions

| Model Number     | A±1 | øB±0.5 | C±2 | D±1 | E±2 | F±0.5 | T1  | T2  | M<br>-0/+0.5 | N<br>-0/+0.5 |
|------------------|-----|--------|-----|-----|-----|-------|-----|-----|--------------|--------------|
| FTFAC-0010N-010A | 120 | 25     | 70  | 12  | 21  | 17    | M3  | M12 | 12.3         | 12.3         |
| FTFAC-0022N-016A | 130 | 28     | 82  | 14  | 21  | 24    | M4  | M16 | 16.3         | 14.3         |
| FTFAC-0022N-032A | 140 | 28     | 82  | 14  | 26  | 24    | M5  | M16 | 16.3         | 14.3         |
| FTFAC-0047N-010A | 125 | 28     | 86  | 14  | 16  | 24    | M3  | M16 | 16.3         | 14.3         |
| FTFAC-0100N-016A | 140 | 32     | 86  | 14  | 22  | 24    | M4  | M16 | 16.3         | 14.3         |
| FTFAC-0100N-032A | 150 | 32     | 90  | 14  | 29  | 24    | M5  | M16 | 16.3         | 14.3         |
| FTFAC-0100N-075A | 192 | 38     | 110 | 16  | 37  | 32    | M8  | M20 | 20.3         | 18.3         |
| FTFAC-0150N-063A | 185 | 38     | 110 | 14  | 32  | 24    | M6  | M16 | 16.3         | 14.3         |
| FTFAC-0220N-130A | 124 | 32     | 46  | 15  | 38  | 27    | M8  | M20 | 20.3         | 18.3         |
| FTFAC-0470N-010A | 210 | 32     | 150 | 14  | 25  | 24    | M3  | M16 | 16.3         | 14.3         |
| FTFAC-0470N-016A | 210 | 38     | 150 | 14  | 25  | 24    | M4  | M16 | 16.3         | 14.3         |
| FTFAC-0470N-025A | 220 | 38     | 150 | 14  | 32  | 24    | M5  | M16 | 16.3         | 14.3         |
| FTFAC-0470N-032A | 220 | 38     | 150 | 14  | 32  | 24    | M5  | M16 | 16.3         | 14.3         |
| FTFAC-0470N-063A | 245 | 38     | 170 | 14  | 35  | 24    | M6  | M16 | 16.3         | 14.3         |
| FTFAC-0470N-075A | 258 | 38     | 170 | 16  | 41  | 27    | M8  | M20 | 20.3         | 18.3         |
| FTFAC-0470N-100A | 258 | 38     | 170 | 16  | 41  | 27    | M8  | M20 | 20.3         | 18.3         |
| FTFAC-0470N-130A | 124 | 32     | 46  | 15  | 38  | 27    | M8  | M20 | 20.3         | 18.3         |
| FTFAC-0470N-200A | 275 | 57     | 180 | 19  | 45  | 40    | M10 | M24 | 24.3         | 22.3         |
| FTFAC-1000N-010A | 210 | 38     | 150 | 14  | 25  | 24    | M3  | M16 | 16.3         | 14.3         |
| FTFAC-1000N-016A | 210 | 38     | 150 | 14  | 25  | 24    | M4  | M16 | 16.3         | 14.3         |
| FTFAC-1000N-025A | 220 | 38     | 150 | 14  | 30  | 24    | M5  | M16 | 16.3         | 14.3         |
| FTFAC-1000N-032A | 220 | 38     | 150 | 14  | 30  | 24    | M5  | M16 | 16.3         | 14.3         |
| FTFAC-1000N-063A | 245 | 57     | 170 | 16  | 35  | 27    | M6  | M20 | 20.3         | 18.3         |
| FTFAC-1000N-075A | 258 | 57     | 170 | 19  | 41  | 40    | M8  | M24 | 24.3         | 22.3         |
| FTFAC-1000N-100A | 258 | 57     | 170 | 19  | 41  | 40    | M8  | M24 | 24.3         | 22.3         |
| FTFAC-1000N-200A | 275 | 57     | 180 | 19  | 45  | 40    | M10 | M24 | 24.3         | 22.3         |
| FTFAC-2200N-010A | 210 | 38     | 150 | 14  | 25  | 24    | M3  | M16 | 16.3         | 14.3         |
| FTFAC-2200N-016A | 210 | 38     | 150 | 14  | 25  | 24    | M4  | M16 | 16.3         | 14.3         |
| FTFAC-2200N-032A | 240 | 57     | 170 | 14  | 32  | 24    | M5  | M16 | 16.3         | 14.3         |
| FTFAC-2200N-063A | 245 | 57     | 170 | 16  | 35  | 27    | M6  | M20 | 20.3         | 18.3         |
| FTFAC-2200N-075A | 258 | 57     | 170 | 19  | 41  | 40    | M8  | M24 | 24.3         | 22.3         |
| FTFAC-2200N-100A | 258 | 57     | 170 | 19  | 41  | 40    | M8  | M24 | 24.3         | 22.3         |
| FTFAC-2200N-200A | 275 | 57     | 180 | 19  | 45  | 40    | M10 | M24 | 24.3         | 22.3         |

| Model Number     | A±1 | øB±0.5 | C±2 | D±1 | E±2 | F±0.5 | T1  | T2  | M    | N    |
|------------------|-----|--------|-----|-----|-----|-------|-----|-----|------|------|
| FTFAC-3300N-010A | 216 | 57     | 160 | 14  | 24  | 24    | M3  | M16 | 16.3 | 14.3 |
| FTFAC-3300N-016A | 220 | 57     | 160 | 14  | 26  | 25    | M4  | M16 | 16.3 | 14.3 |
| FTFAC-3300N-032A | 240 | 57     | 170 | 14  | 32  | 25    | M5  | M16 | 16.3 | 14.3 |
| FTFAC-3300N-063A | 245 | 57     | 170 | 16  | 35  | 27    | M6  | M20 | 20.3 | 18.3 |
| FTFAC-3300N-100A | 258 | 57     | 170 | 19  | 41  | 32    | M8  | M24 | 24.3 | 22.3 |
| FTFAC-3300N-200A | 275 | 57     | 180 | 19  | 45  | 40    | M10 | M24 | 24.3 | 22.3 |
| FTFAC-4700N-063A | 245 | 57     | 170 | 16  | 35  | 27    | M6  | M20 | 20.3 | 18.3 |
| FTFAC-4700N-100A | 258 | 57     | 170 | 19  | 41  | 40    | M8  | M24 | 24.3 | 22.3 |
| FTFAC-4700N-200A | 275 | 57     | 180 | 19  | 45  | 40    | M10 | M24 | 24.3 | 22.3 |

All dimensions are in mm .

## Torque Details

| Recommended Torque  | M3  | M4  | M6  | M8 | M10 | M10X1 | M12X1 | M16X1 | M20X1 | M24X1 |
|---------------------|-----|-----|-----|----|-----|-------|-------|-------|-------|-------|
| Terminal Thread(Nm) | 0.5 | 1.2 | 2.5 | 5  | 8   | -     | -     | -     | -     | -     |
| Mounting Thread(Nm) | -   | -   | -   | -  | -   | 2     | 3     | 4     | 7     | 8     |

## Insertion Loss

Typical values at 50 Ω

### 10nF

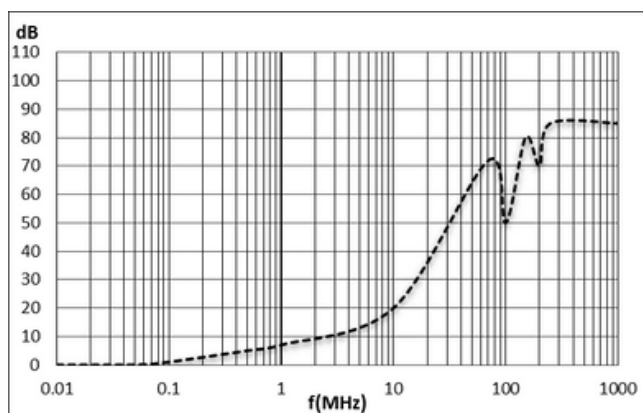

### 22nF

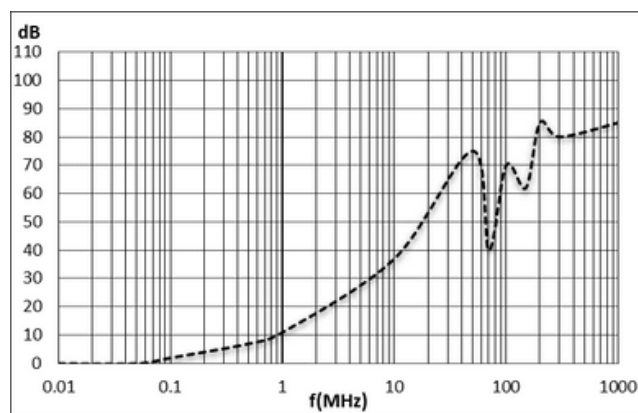

### 47nF

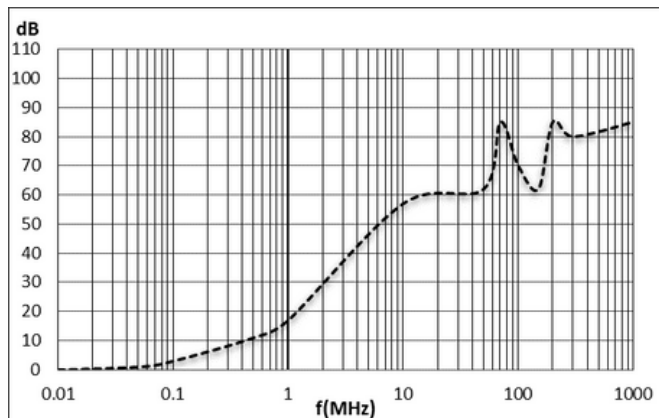

### 100nF

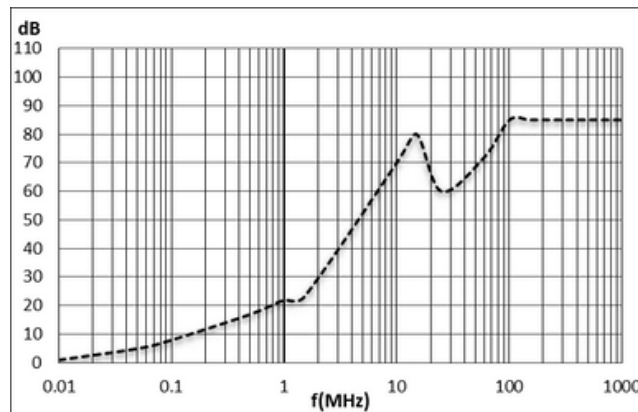

### 150nF

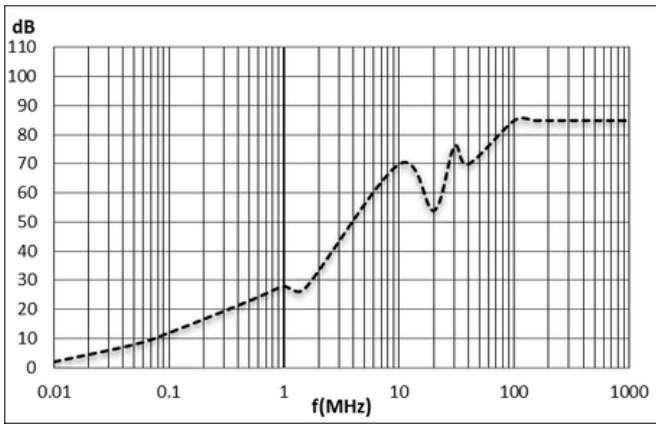

### 220nF

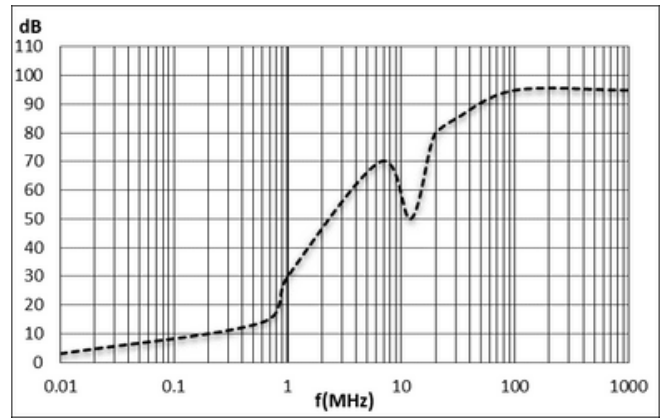

### 470nF

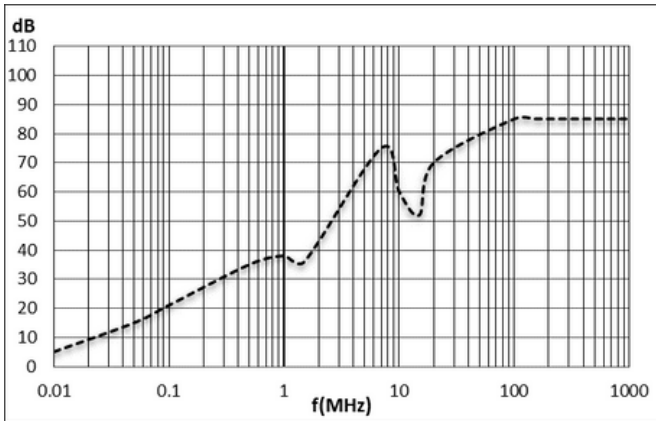

### 1000nF

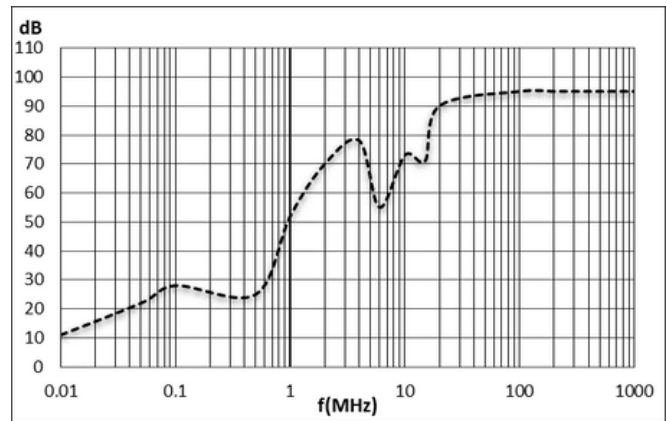

### 2200nF

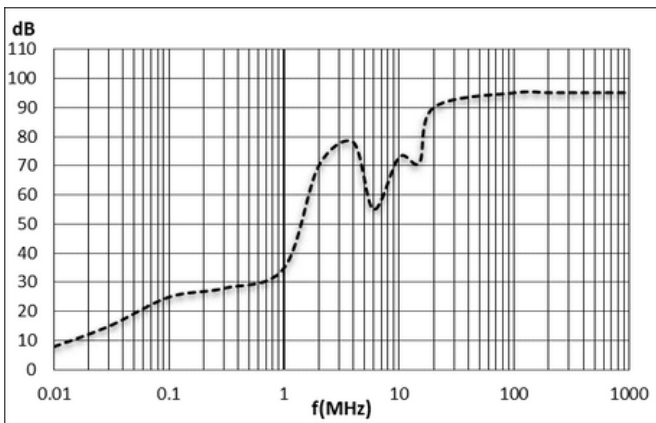

### 3300nF

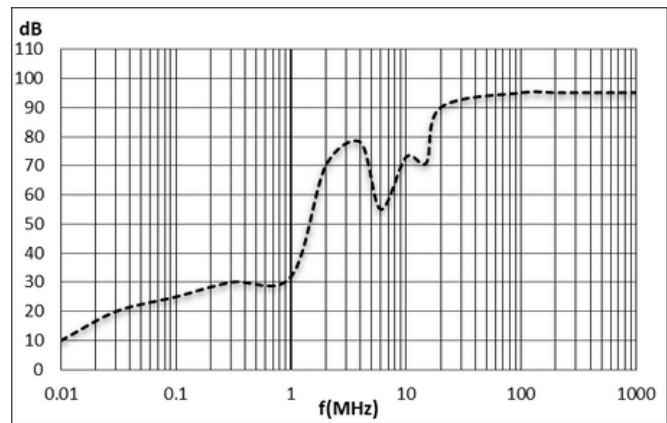

### 4700nF

