

Features:

- High EMI attenuation
- Compliance with Class C2 or C1 limits.
- Book-style with convenient size
- Current rating from 10A to 230A
- Low leakage current

Typical applications:

- Variable speed drives and power drive systems (PDS).
- Machine tool and machinery equipment.
- IT power distribution networks.
- Inverters, converters
- Process automation equipment.
- Three-phase power supplies.

DATA SHEET
**THREE PHASE EMI FILTER-
TMF3221/TMF3222**
Description

These series of filters designed for motor and power drive systems which can provide superior attenuation performance and suppress conducted noise even when high interference level are present.

Technical Specifications:

Maximum continuous operating voltage	: 530VAC (TMF3221) (TMF3222) (TMF3222IT) 760VAC (TMF3222HV) (TMF3222HVIT)
Operating Frequency	: 50/60 Hz
Rated currents	: 10A to 230A @50°C
High potential test voltage	: L -> G 2884 VDC for 2 s (TMF3221) (TMF3222) L -> L 2279 VDC for 2 s (TMF3221) (TMF3222) L -> G 3528 VDC for 2 s(TMF3222HV) L -> L 3268 VDC for 2 s(TMF3222HV)
Overload Capability	: 4x rated current at switch on, 135% of rated current for 15Mins
Flammability according to	: UL 94 V-0
Temperature range	: -40°C to +100°C
Climatic class	: 40/100/21
Design corresponding to	: UL 60939-3 & IEC 60939-1&2
Protection category	: IP 20
Overvoltage category	: III acc. IEC 60664-1
Compliance with insulation requirement	: > 1MOhm acc. to IEC 60204-1

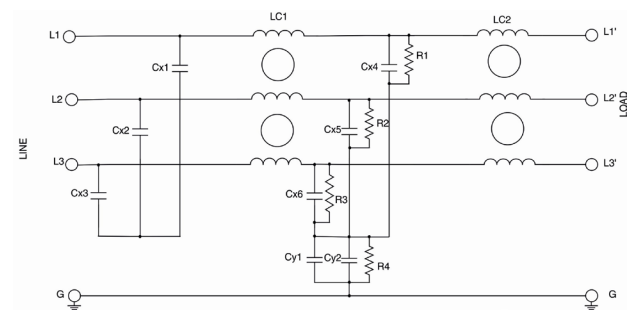
Typical Circuit Diagram:



Note: IT and HVIT versions without discharge resistor to ground.

Filter Selection Table:

Standard Performance Version									
Model Number	Part Number	Current Rating @ 50°C A	Leakage current @ 520 VAC/50 Hz (mA)			Power loss @25°C / 50Hz (W)	Termination 	Weight Approx. (Kg)	Enclosure
			C3	C6	C9				
TMF3221-10A-2-C3-RB1	E108365-1	10	0.4	-	-	7.5	-2 (06)	0.7	Q
TMF3221-10A-2-C6-RB1	E108365-2	10	-	2.2	-	7.5	-2 (06)	0.7	Q
TMF3221-10A-2-C9-RB1	E108365-3	10	-	-	4.2	7.5	-2 (06)	0.7	Q
TMF3221-16A-2-C3-RB1	E108366-1	16	0.4	-	-	9.5	-2 (06)	0.8	R
TMF3221-16A-2-C6-RB1	E108366-2	16	-	2.4	-	9.5	-2 (06)	0.8	R
TMF3221-16A-2-C9-RB1	E108366-3	16	-	-	4.3	9.5	-2 (06)	0.8	R
TMF3221-20A-2-C3-RB1	E108367-1	20	0.4	-	-	10	-2 (06)	0.9	S
TMF3221-20A-2-C6- RB1	E108367-2	20	-	2.5	-	10	-2 (06)	0.9	S
TMF3221-20A-2-C9-RB1	E108367-3	20	-	-	4.9	10	-2 (06)	0.9	S
TMF3221-25A-2-C3-RB1	E108369-1	25	0.4	-	-	11.5	-2 (06)	1.0	S
TMF3221-25A-2-C6-RB1	E108369-2	25	-	2.5	-	11.5	-2 (06)	1.0	S
TMF3221-25A-2-C9-RB1	E108369-3	25	-	-	4.9	11.5	-2 (06)	1.0	S
TMF3221-40A-2-C3-RB1	E108370-1	40	0.4	-	-	23	-2 (06)	1.5	T
TMF3221-40A-2-C6-RB1	E108370-2	40	-	2.5	-	23	-2 (06)	1.5	T
TMF3221-40A-2-C9-RB1	E108370-3	40	-	-	4.9	23	-2 (06)	1.5	T
TMF3221-50A-2-C3-RB1	E108371-1	50	0.4	-	-	25.5	-2 (16)	2.1	U
TMF3221-50A-2-C6-RB1	E108371-2	50	-	2.5	-	25.5	-2 (16)	2.1	U
TMF3221-50A-2-C9-RB1	E108371-3	50	-	-	4.9	25.5	-2 (16)	2.1	U
TMF3221-63A-2-C3-RB1	E108372-1	63	0.4	-	-	32.5	-2 (16)	2.2	U
TMF3221-63A-2-C6-RB1	E108372-2	63	-	2.5	-	32.5	-2 (16)	2.2	U
TMF3221-63A-2-C9-RB1	E108372-3	63	-	-	4.9	32.5	-2 (16)	2.2	U
TMF3221-80A-2-C3-RB1	E108373-1	80	0.4	-	-	33	-2 (35)	3.4	F
TMF3221-80A-2-C6-RB1	E108373-2	80	-	2.7	-	33	-2 (35)	3.4	F
TMF3221-80A-2-C9-RB1	E108373-3	80	-	-	5.6	33	-2 (35)	3.4	F
TMF3221-100A-2-C3-RB1	E108374-1	100	0.4	-	-	33.5	-2 (50)	4.2	G
TMF3221-100A-2-C6-RB1	E108374-2	100	-	2.7	-	33.5	-2 (50)	4.2	G
TMF3221-100A-2-C9-RB1	E108374-3	100	-	-	5.6	33.5	-2 (50)	4.2	G
TMF3221-125A-2-C3-RB1	E108375-1	125	0.4	-	-	37.5	-2 (50)	4.6	G
TMF3221-125A-2-C6-RB1	E108375-2	125	-	2.7	-	37.5	-2 (50)	4.6	G
TMF3221-125A-2-C9-RB1	E108375-3	125	-	-	5.6	37.5	-2 (50)	4.6	G
TMF3221-160A-2-C3-RB1	E108376-1	160	0.4	-	-	38.5	-2 (95)	6	H
TMF3221-160A-2-C6-RB1	E108376-2	160	-	2.7	-	38.5	-2 (95)	6	H
TMF3221-160A-2-C9-RB1	E108376-3	160	-	-	5.6	38.5	-2 (95)	6	H
TMF3221-230A-2-C3-RB1	E108377-1	230	0.4	-	-	48	-2 (95)	8.8	V
TMF3221-230A-2-C6-RB1	E108377-2	230	-	2.7	-	48	-2 (95)	8.8	V
TMF3221-230A-2-C9-RB1	E108377-3	230	-	-	5.9	48	-2 (95)	8.8	V

High Performance Version

Model Number	Part Number	Current Rating @ 50°C	Leakage current @ 520 VAC/50 Hz (mA)					Power loss @25°C / 50Hz (W)	Termination	Weight Approx. (Kg)	Enclosure
		A	C2	C3	C6	C11					
TMF3222-10A-2-C2-RB1	E108378-1	10	0.1	-	-	-	7.5	-2 (06)	0.8	A	
TMF3222-10A-2-C3-RB1	E108378-2	10	-	0.4	-	-	7.5	-2 (06)	0.8	A	
TMF3222-10A-2-C6-RB1	E108378-3	10	-	-	2.5	-	7.5	-2 (06)	0.8	A	
TMF3222-10A-2-C11-RB1	E108378-4	10	-	-	-	6	7.5	-2 (06)	0.8	A	
TMF3222-16A-2-C2-RB1	E108379-1	16	0.1	-	-	-	10.5	-2 (06)	1	B	
TMF3222-16A-2-C3-RB1	E108379-2	16	-	0.4	-	-	10.5	-2 (06)	1	B	
TMF3222-16A-2-C6-RB1	E108379-3	16	-	-	2.5	-	10.5	-2 (06)	1	B	
TMF3222-16A-2-C11-RB1	E108379-4	16	-	-	-	6	10.5	-2 (06)	1	B	
TMF3222-20A-2-C2-RB1	E108380-1	20	0.1	-	-	-	11	-2 (06)	1.2	C	
TMF3222-20A-2-C3-RB1	E108380-2	20	-	0.4	-	-	11	-2 (06)	1.2	C	
TMF3222-20A-2-C6-RB1	E108380-3	20	-	-	2.5	-	11	-2 (06)	1.2	C	
TMF3222-20A-2-C11-RB1	E108380-4	20	-	-	-	6	11	-2 (06)	1.2	C	
TMF3222-25A-2-C2-RB1	E108381-1	25	0.1	-	-	-	18	-2 (06)	1.2	C	
TMF3222-25A-2-C3-RB1	E108381-2	25	-	0.4	-	-	18	-2 (06)	1.2	C	
TMF3222-25A-2-C6-RB1	E108381-3	25	-	-	2.5	-	18	-2 (06)	1.2	C	
TMF3222-25A-2-C11-RB	E108381-4	25	-	-	-	6	18	-2 (06)	1.2	C	
TMF3222-40A-2-C2-RB1	E108382-1	40	0.1	-	-	-	22	-2 (06)	1.8	D	
TMF3222-40A-2-C3-RB1	E108382-2	40	-	0.4	-	-	22	-2 (06)	1.8	D	
TMF3222-40A-2-C6-RB1	E108382-3	40	-	-	3.5	-	22	-2 (06)	1.8	D	
TMF3222-40A-2-C11-RB1	E108382-4	40	-	-	-	6	22	-2 (06)	1.8	D	
TMF3222-50A-2-C2-RB1	E108383-1	50	0.1	-	-	-	30	-2 (16)	2.5	E	
TMF3222-50A-2-C3-RB1	E108383-2	50	-	0.4	-	-	30	-2 (16)	2.5	E	
TMF3222-50A-2-C6-RB1	E108383-3	50	-	-	2.6	-	30	-2 (16)	2.5	E	
TMF3222-50A-2-C11-RB1	E108383-4	50	-	-	-	6.6	30	-2 (16)	2.5	E	
TMF3222-63A-2-C2-RB1	E108384-1	63	0.1	-	-	-	35	-2 (16)	2.7	E	
TMF3222-63A-2-C3-RB1	E108384-2	63	-	0.4	-	-	35	-2 (16)	2.7	E	
TMF3222-63A-2-C6-RB1	E108384-3	63	-	-	2.6	-	35	-2 (16)	2.7	E	
TMF3222-63A-2-C11-RB1	E108384-4	63	-	-	-	6.6	35	-2 (16)	2.7	E	
TMF3222-80A-2-C2-RB1	E108385-1	80	0.1	-	-	-	29	-2 (35)	4.3	F	
TMF3222-80A-2-C3-RB1	E108385-2	80	-	0.4	-	-	29	-2 (35)	4.3	F	
TMF3222-80A-2-C6-RB1	E108385-3	80	-	-	2.7	-	29	-2 (35)	4.3	F	
TMF3222-80A-2-C11-RB1	E108385-4	80	-	-	-	7.1	29	-2 (35)	4.3	F	
TMF3222-100A-2-C2-RB1	E108386-1	100	0.1	-	-	-	36	-2 (50)	5.1	G	
TMF3222-100A-2-C3-RB1	E108386-2	100	-	0.4	-	-	36	-2 (50)	5.1	G	
TMF3222-100A-2-C6-RB1	E108386-3	100	-	-	2.7	-	36	-2 (50)	5.1	G	

High Performance Version										
Model Number	Part Number	Current Rating @ 50°C	Leakage current @ 520 VAC/50 Hz (mA)				Power loss @25°C / 50Hz (W)	Termination 	Weight Approx. (Kg)	Enclosure
			A	C2	C3	C6				
TMF3222-100A-2-C11-RB1	E108386-4	100	-	-	-	7.1	36	-2 (50)	5.1	G
TMF3222-125A-2-C2-RB1	E108387-1	125	0.1	-	-	-	42.5	-2 (50)	5.0	G
TMF3222-125A-2-C3-RB1	E108387-2	125	-	0.4	-	-	42.5	-2 (50)	5.0	G
TMF3222-125A-2-C6-RB1	E108387-3	125	-	-	2.7	-	42.5	-2 (50)	5.0	G
TMF3222-125A-2-C11-RB1	E108387-4	125	-	-	-	7.1	42.5	-2 (50)	5.0	G
TMF3222-160A-2-C2-RB1	E108388-1	160	0.1	-	-	-	46.5	-2 (95)	6.6	H
TMF3222-160A-2-C3-RB1	E108388-2	160	-	0.4	-	-	46.5	-2 (95)	6.6	H
TMF3222-160A-2-C6-RB1	E108388-3	160	-	-	2.7	-	46.5	-2 (95)	6.6	H
TMF3222-160A-2-C11-RB1	E108388-4	160	-	-	-	7.1	46.5	-2 (95)	6.6	H
TMF3222-230A-2-C2-RB1	E108389-1	230	0.1	-	-	-	48	-2 (95)	9.3	V
TMF3222-230A-2-C3-RB1	E108389-2	230	-	0.4	-	-	48	-2 (95)	9.3	V
TMF3222-230A-2-C6-RB1	E108389-3	230	-	-	2.7	-	48	-2 (95)	9.3	V
TMF3222-230A-2-C11-RB1	E108389-4	230	-	-	-	7.1	48	-2 (95)	9.3	V

High Performance for IT Power Networks							
Model Number	Part Number	Current Rating @ 50°C A	Leakage current @ 520 VAC/50 Hz (mA)	Power loss @25°C / 50Hz (W)	Termination 	Weight Approx. (Kg)	Enclosure
TMF3222IT-16A-2-C10-RB1	E108391-1	16	5.9	10	-2 (06)	1.3	J
TMF3222IT-20A-2-C10-RB1	E108392-1	20	5.9	13.5	-2 (06)	1.6	K
TMF3222IT-25A-2-C10-RB1	E108393-1	25	5.9	16	-2 (06)	1.6	K
TMF3222IT-40A-2-C10-RB1	E108394-1	40	5.9	19	-2 (06)	2.8	L
TMF3222IT-50A-2-C10-RB1	E108395-1	50	6.5	24	-2 (16)	2.8	M
TMF3222IT-63A-2-C10-RB1	E108396-1	63	6.5	30	-2 (16)	2.9	M
TMF3222IT-80A-2-C10-RB1	E108397-1	80	7.0	30	-2 (35)	4.6	N
TMF3222IT-100A-2-C10-RB1	E108398-1	100	7.0	33	-2 (50)	5.4	O
TMF3222IT-125A-2-C10-RB1	E108399-1	125	7.0	42.5	-2 (50)	5.3	O
TMF3222IT-160A-2-C10-RB1	E108400-1	160	7.0	46.5	-2 (95)	6.9	P
TMF3222IT-230A-2-C10-RB1	E108401-1	230	7.0	48	-2 (95)	9.3	V

High Voltage Version

Model Number	Part Number	Current Rating @ 50°C A	Leakage current @ 520 VAC/50 Hz (mA)		Power loss @25°C / 50Hz (W)	Termination 	Weight Approx. (Kg)	Enclosure
			C5	C12				
			TMF3222HV-10A-2-C5-RB1	E108402-1		10	2.2	
TMF3222HV-10A-2-C12-RB1	E108402-2	10	-	8.4	7	-2 (06)	1.2	I
TMF3222HV-16A-2-C5-RB1	E108403-1	16	2.5	-	11	-2 (06)	1.5	J
TMF3222HV-16A-2-C12-RB1	E108403-2	16	-	9.2	11	-2 (06)	1.5	J
TMF3222HV-20A-2-C5-RB1	E108404-1	20	2.5	-	13	-2 (06)	1.8	K
TMF3222HV-20A-2-C12-RB1	E108404-2	20	-	10.9	13	-2 (06)	1.8	K
TMF3222HV-25A-2-C5-RB1	E108405-1	25	2.5	-	15	-2 (06)	1.9	K
TMF3222HV-25A-2-C12-RB1	E108405-2	25	-	10.9	15	-2 (06)	1.9	K
TMF3222HV-40A-2-C5-RB1	E108406-1	40	2.6	-	20	-2 (06)	2.9	L
TMF3222HV-40A-2-C12-RB1	E108406-2	40	-	12.4	20	-2 (06)	2.9	L
TMF3222HV-50A-2-C5-RB1	E108407-1	50	2.6	-	26.5	-2 (16)	3.3	M
TMF3222HV-50A-2-C12-RB1	E108407-2	50	-	12.4	26.5	-2 (16)	3.3	M
TMF3222HV-63A-2-C5-RB1	E108408-1	63	2.6	-	33.5	-2 (16)	3.5	M
TMF3222HV-63A-2-C12-RB1	E108408-2	63	-	12.4	33.5	-2 (16)	3.5	M
TMF3222HV-80A-2-C5-RB1	E108409-1	80	2.6	-	29	-2 (35)	4.9	N
TMF3222HV-80A-2-C12-RB1	E108409-2	80	-	12.4	29	-2 (35)	4.9	N
TMF3222HV-100A-2-C5-RB1	E108411-1	100	2.6	-	33	-2 (50)	5.8	O
TMF3222HV-100A-2-C12-RB1	E108411-2	100	-	12.4	33	-2 (50)	5.8	O
TMF3222HV-125A-2-C5-RB1	E108412-1	125	2.6	-	42	-2 (50)	5.9	O
TMF3222HV-125A-2-C12-RB2	E108412-2	125	-	12.4	42	-2 (50)	5.9	O
TMF3222HV-160A-2-C5-RB1	E108413-1	160	2.6	-	46.5	-2 (95)	7.2	P
TMF3222HV-160A-2-C12-RB3	E108413-2	160	-	12.4	46.5	-2 (95)	7.2	P
TMF3222HV-230A-2-C5-RB1	E108414-1	230	2.6	-	48	-2 (95)	9.3	V
TMF3222HV-230A-2-C12-RB1	E108414-2	230	-	12.4	48	-2 (95)	9.3	V

High Voltage Version for IT Power Networks

Model Number	Part Number	Current Rating @ 50°C A	Leakage current @ 520 VAC/50 Hz (mA)		Power loss @25°C / 50Hz (W)	Termination 	Weight Approx. (Kg)	Enclosure
			C6	C14				
TMF3222HVIT-10A-2-C6-RB1	E108415-1	10	3.6	-	7	-2 (06)	1.2	I
TMF3222HVIT-10A-2-C14-RB1	E108415-2	10	-	4.6	7	-2 (06)	1.2	I
TMF3222HVIT-16A-2-C6-RB1	E108416-1	16	3.7	-	11	-2 (06)	1.5	J
TMF3222HVIT-16A-2-C14-RB1	E108416-2	16	-	6.8	11	-2 (06)	1.5	J
TMF3222HVIT-20A-2-C6-RB1	E108417-1	20	3.7	-	13	-2 (06)	1.8	K
TMF3222HVIT-20A-2-C14-RB1	E108417-2	20	-	6.8	13	-2 (06)	1.8	K
TMF3222HVIT-25A-2-C6-RB1	E108418-1	25	3.7	-	15	-2 (06)	1.9	K
TMF3222HVIT-25A-2-C14-RB1	E108418-2	25	-	6.8	15	-2 (06)	1.9	K
TMF3222HVIT-40A-2-C6-RB1	E108419-1	40	3.7	-	19.5	-2 (06)	2.9	L
TMF3222HVIT-40A-2-C14-RB1	E108419-2	40	-	6.8	19.5	-2 (06)	2.9	L
TMF3222HVIT-50A-2-C6-RB1	E108420-1	50	3.7	-	26.5	-2 (16)	3.3	M
TMF3222HVIT-50A-2-C14-RB1	E108420-2	50	-	6.8	26.5	-2 (16)	3.3	M
TMF3222HVIT-63A-2-C6-RB1	E108421-1	63	3.7	-	33.5	-2 (16)	3.5	M
TMF3222HVIT-63A-2-C14-RB1	E108421-2	63	-	6.8	33.5	-2 (16)	3.5	M
TMF3222HVIT-80A-2-C6-RB1	E108422-1	80	3.7	-	29	-2 (35)	4.9	N
TMF3222HVIT-80A-2-C14-RB1	E108422-2	80	-	6.8	29	-2 (35)	4.9	N
TMF3222HVIT-100A-2-C6-RB1	E108423-1	100	3.7	-	33	-2 (50)	5.8	O
TMF3222HVIT-100A-2-C14-RB1	E108423-2	100	-	6.8	33	-2 (50)	5.8	O
TMF3222HVIT-125A-2-C6-RB1	E108424-1	125	3.7	-	42.5	-2 (50)	5.9	O
TMF3222HVIT-125A-2-C14-RB1	E108424-2	125	-	6.8	42.5	-2 (50)	5.9	O
TMF3222HVIT-160A-2-C6-RB1	E108425-1	160	3.7	-	46.5	-2 (95)	7.2	P
TMF3222HVIT-160A-2-C14-RB1	E108425-2	160	-	6.8	46.5	-2 (95)	7.2	P
TMF3222HVIT-230A-2-C6-RB1	E108426-1	230	3.7	-	47.5	-2 (95)	9.3	V
TMF3222HVIT-230A-2-C14-RB1	E108426-2	230	-	12.4	47.5	-2 (95)	9.3	V

Note : Standardized calculated leakage current according to the IEC60939 under normal operating conditions.

Insertion Loss : Common mode _____ Differential Mode

Per CISPR 17; C=50 Ω/50 Ω D=50 Ω/50 Ω

TMF3221-10-1-C9-RB1

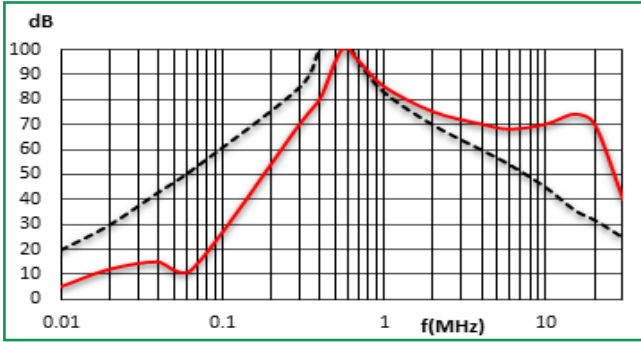

TMF3221-16-1-C9-RB1

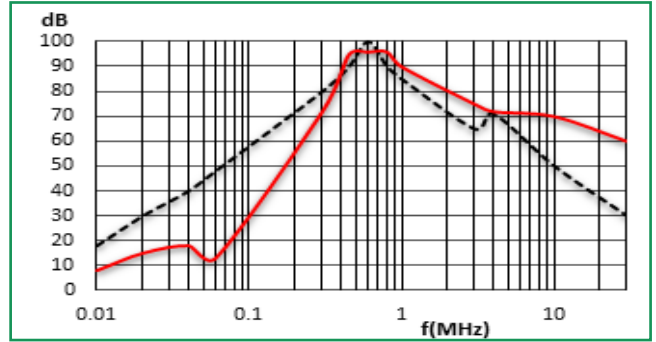

TMF3221-20-1-C9-RB1

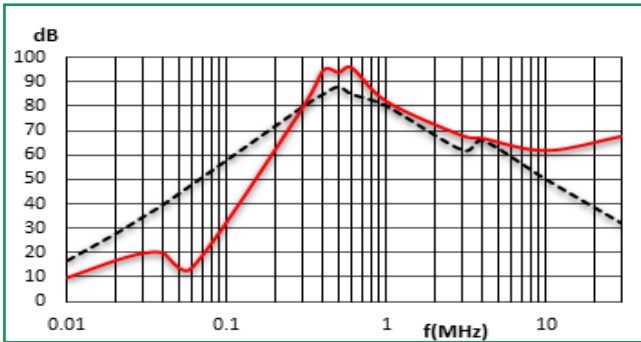

TMF3221-25-1-C9-RB1

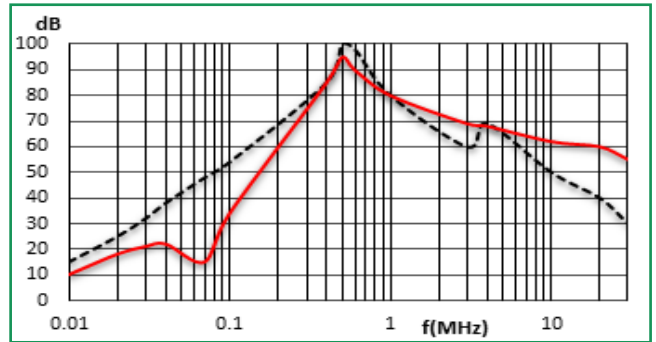

TMF3221-40-1-C9-RB1

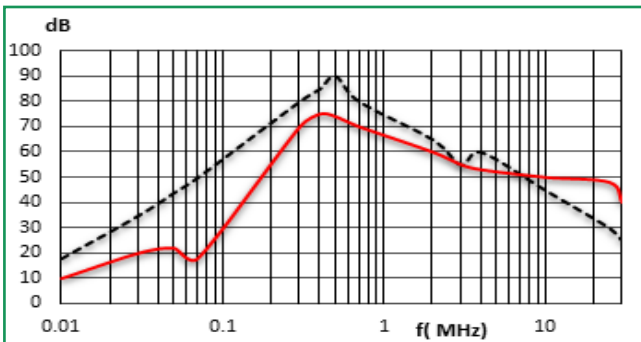

TMF3221-50-1-C9-RB1

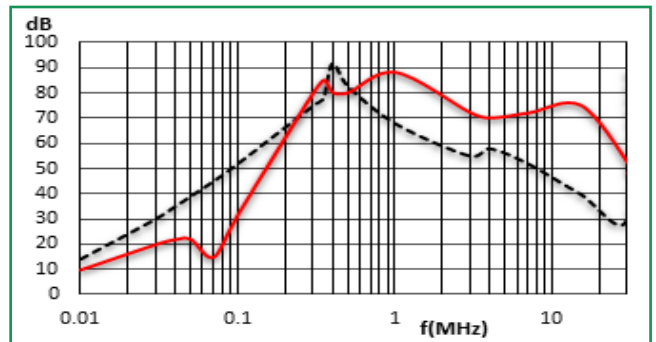

TMF3221-63-1-C9-RB1

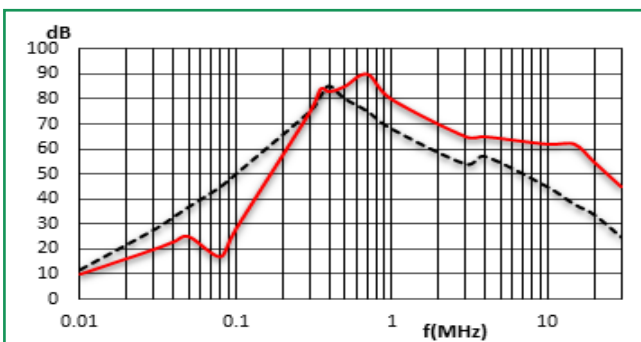

TMF3221-80-1-C9-RB1

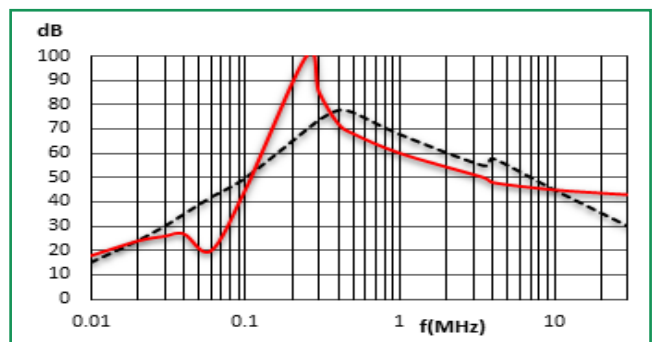

TMF3221-100-1-C9-RB1

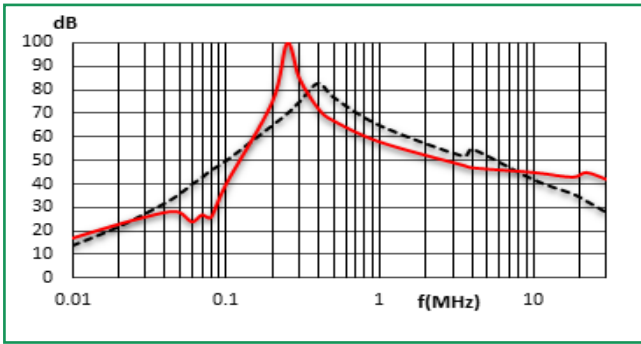

TMF3221-125-1-C9-RB1

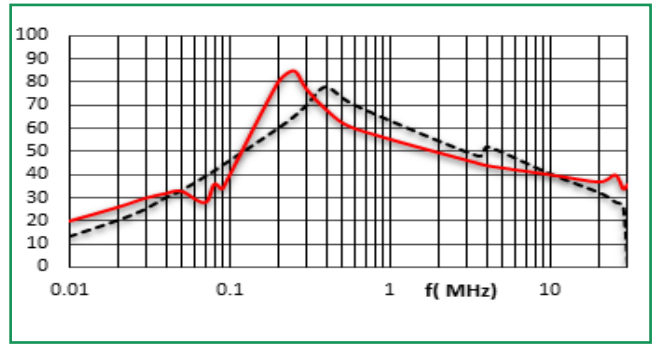

TMF3221-160-1-C9-RB1

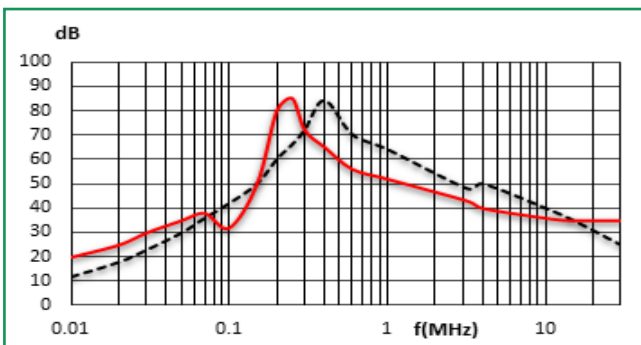

TMF3221-230-1-C9-RB1

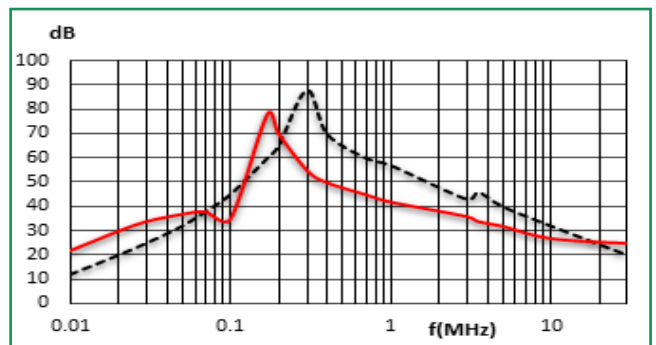

TMF3222-10-1-C11-RB1

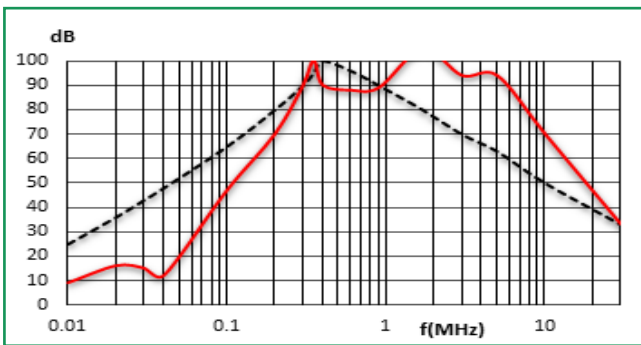

TMF3222-16-1-C11-RB1

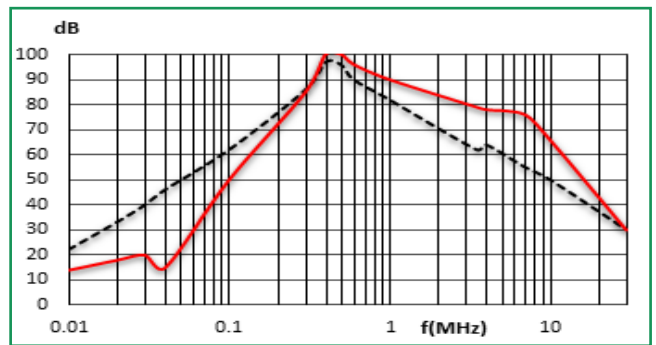

TMF3222-20-1-C11-RB1

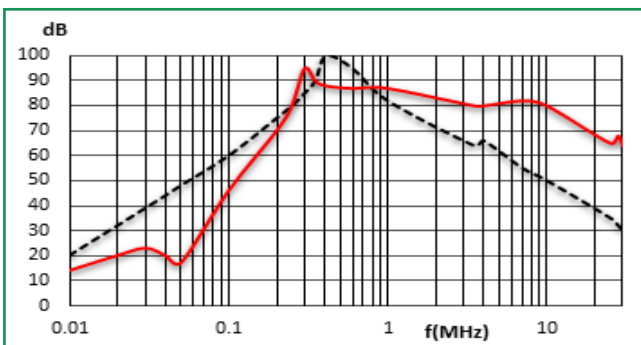

TMF3222-25-1-C11-RB1

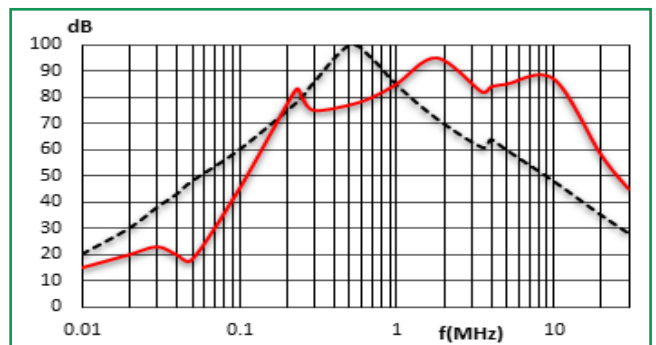

TMF3222-40-1-C11-RB1

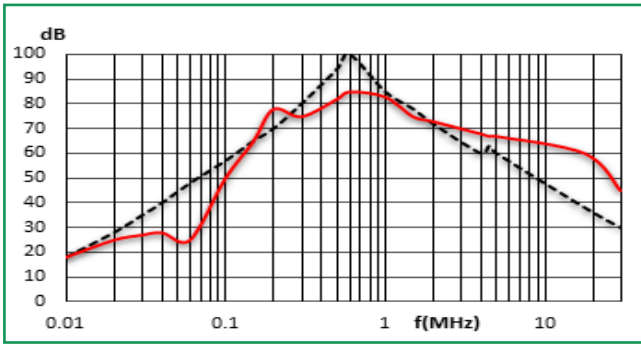

TMF3222-50-1-C11-RB1

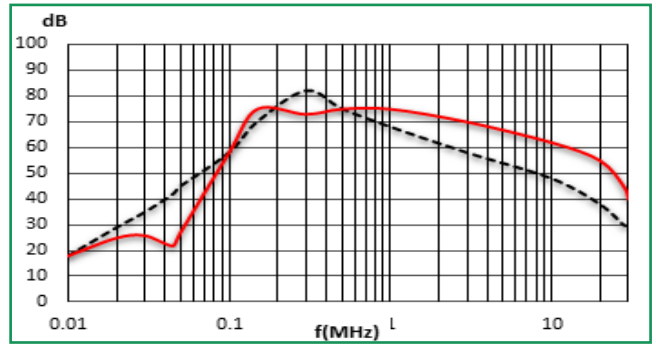

TMF3222-63-1-C11-RB1

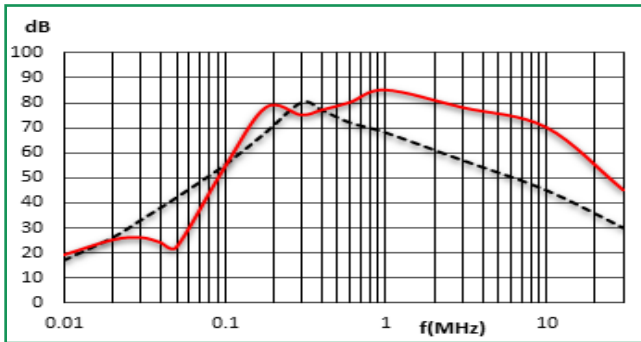

TMF3222-80-1-C11-RB1

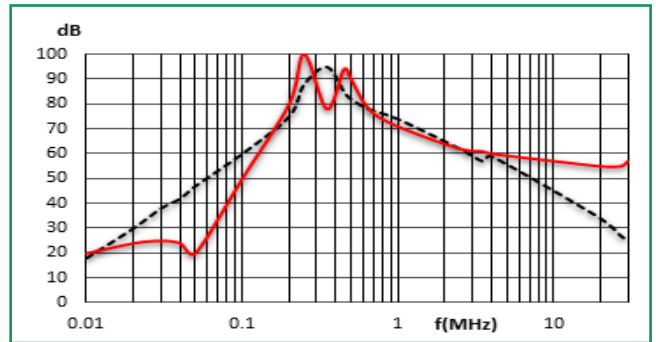

TMF3222-100-1-C11-RB1

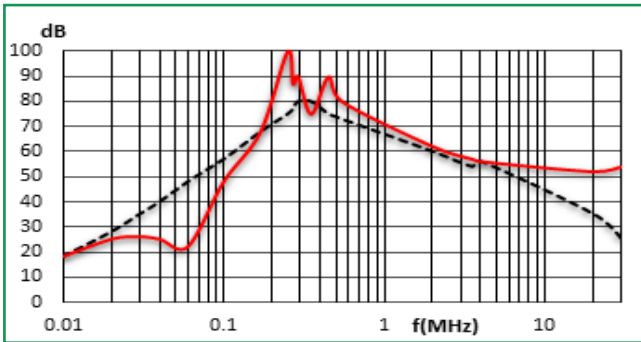

TMF3222-125-1-C11-RB1

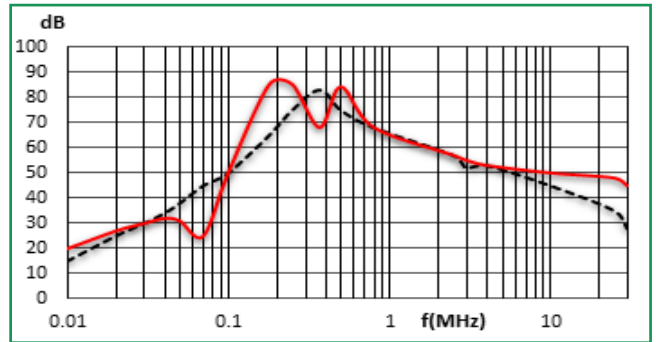

TMF3222-160-1-C11-RB1

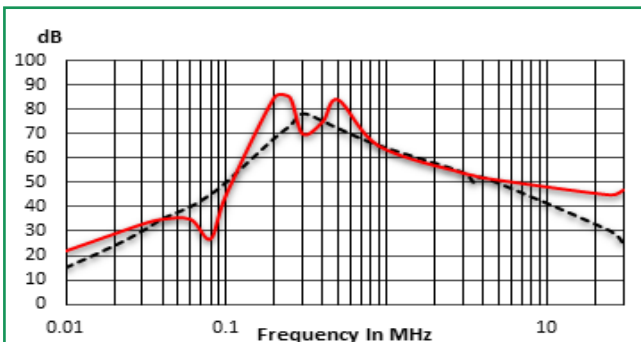

TMF3222-230-1-C11-RB1

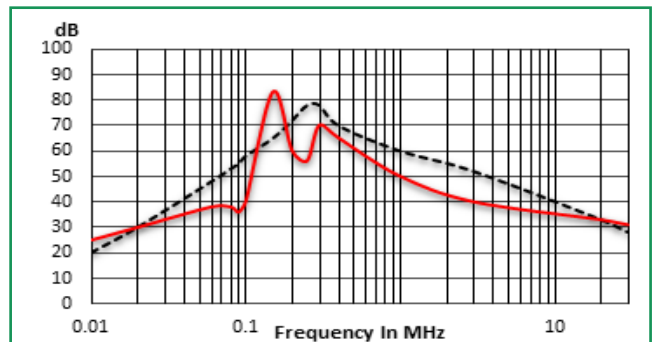

TMF3222-10-1-C3-RB1

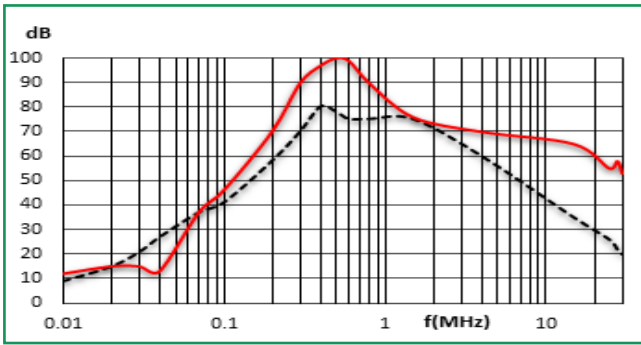

TMF3222-16-1-C3-RB1

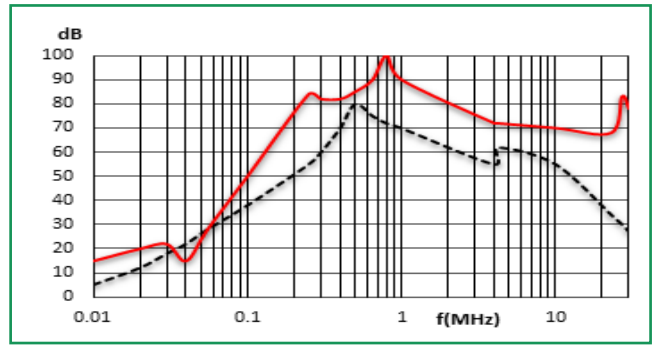

TMF3222-20-1-C3-RB1

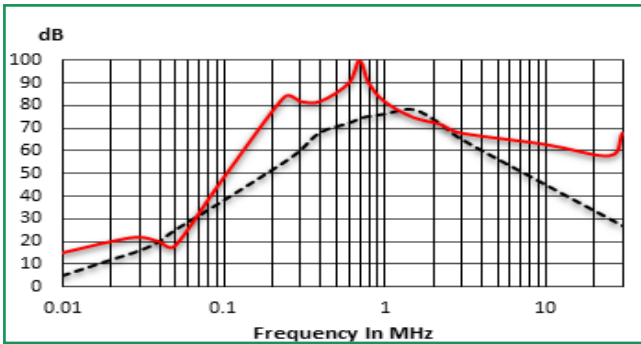

TMF3222-25-1-C3-RB1

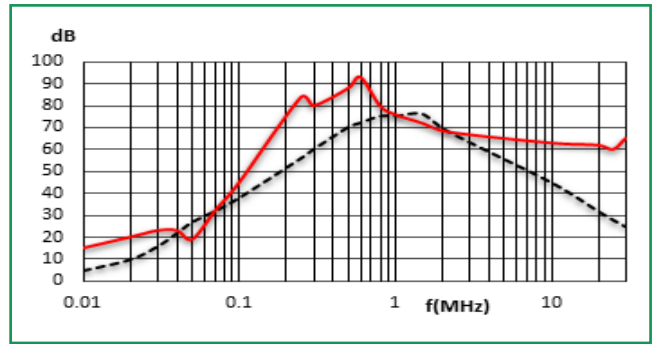

TMF3222-40-1-C3-RB1

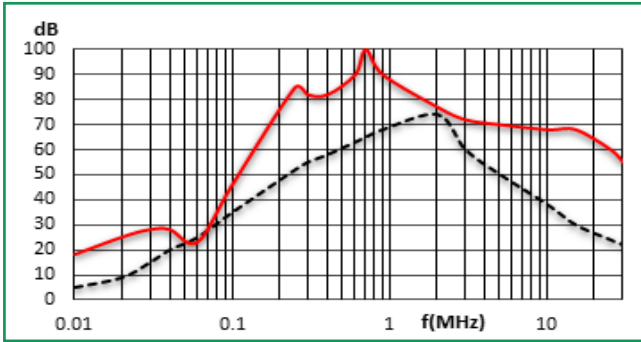

TMF3222-50-1-C3-RB1

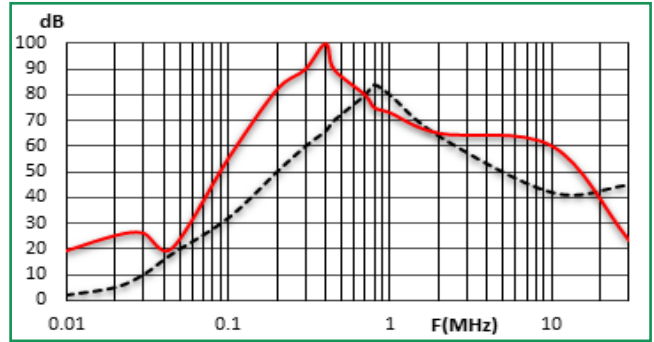

TMF3222-63-1-C3-RB1

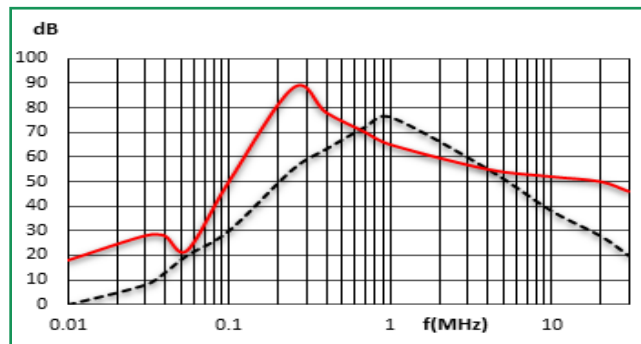

TMF3222-80-1-C3-RB1

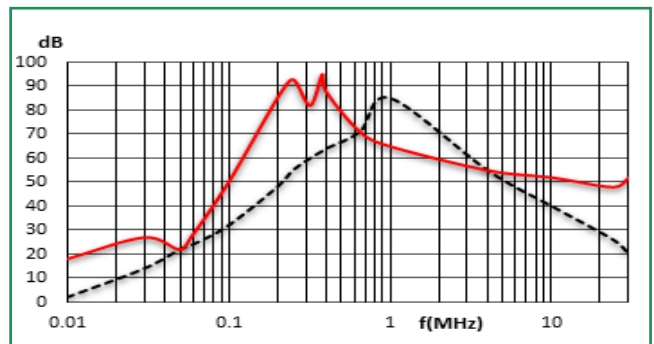

TMF3222-100-1-C3-RB1

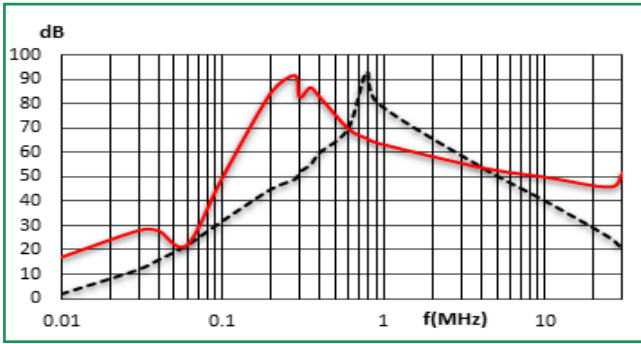

TMF3222-125-1-C3-RB1

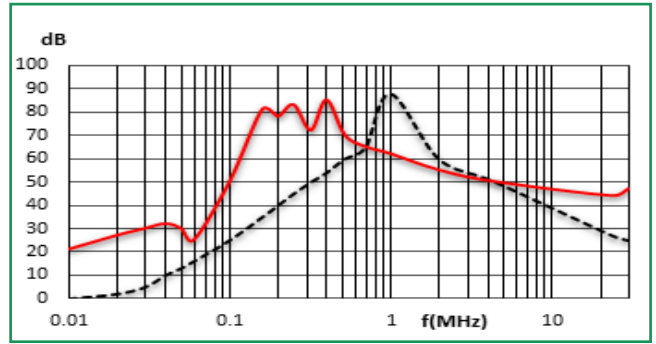

TMF3222-160-1-C3-RB1

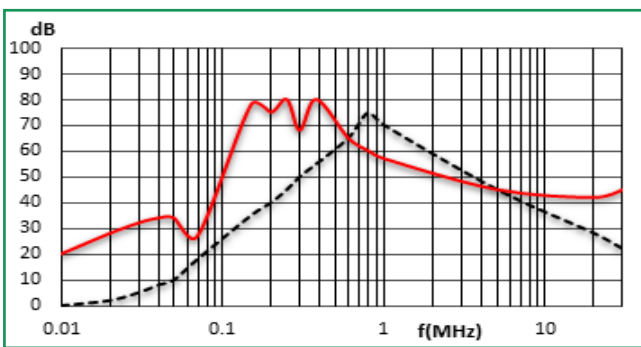

TMF3222-230-1-C2-RB1

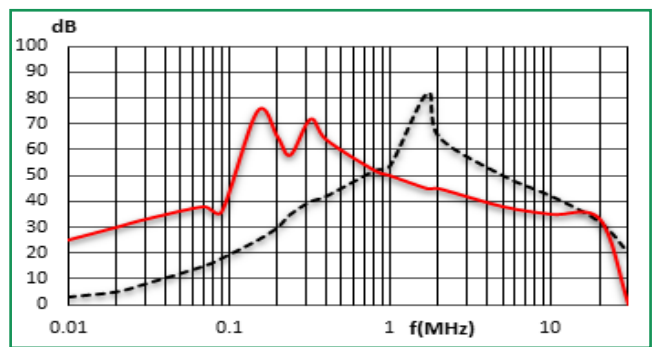

Mechanical Drawing:

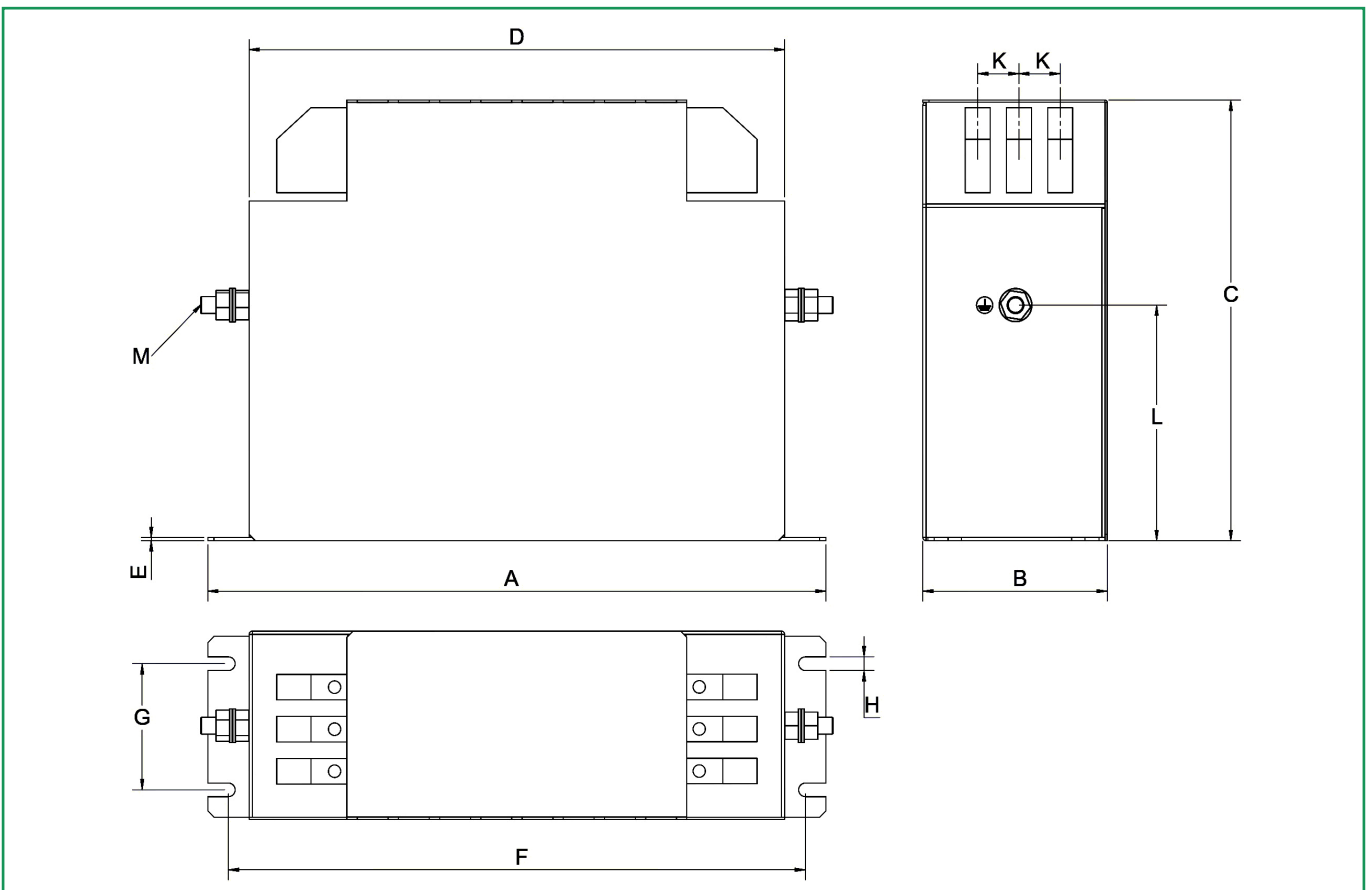

Mechanical dimensions:

Enclosure	A	B	C	D	E	F	G	H	K	L±1	M
A	185	40	120	157	0.8	175	20	4.5	11	76	M5
B	195	45	140	164	0.8	180	25	5.4	11	93	M5
C	210	45	145	174	0.8	195	25	5.4	13	96	M5
D	235	50	168	207	1.0	220	30	5.4	13	115	M6
E	255	65	180	226	1.0	240	45	5.4	16	120	M6
F	290	80	205	250	1.2	270	50	6.5	22	110	M6
G	300	90	210	260	1.5	280	60	6.5	25	112	M8
H	310	100	225	270	1.5	290	70	6.5	28	110	M10
I	230	50	132	203	0.8	220	30	4.5	12.5	88	M5
J	230	55	159	198	0.8	215	35	5.4	13	112	M5
K	245	55	167	212	0.8	230	35	5.4	13	118	M5
L	265	60	191	237	1.0	250	40	5.4	13	135	M6
M	265	70	194	237	1.0	250	50	5.4	16	133	M6
N	310	95	220	270	1.2	290	65	6.5	22	125	M6
O	320	95	230	280	1.5	300	65	6.5	25	127	M8
P	330	100	240	290	1.5	310	70	6.5	30	127	M10
Q	180	40	112	153	0.8	170	20	4.5	11	68	M5
R	200	45	120	170	0.8	185	25	5.4	11	76	M5
S	205	45	132	173	0.8	190	25	5.4	13	83	M5
T	215	50	147	185	1.0	200	30	5.4	13	95	M6
U	220	65	180	186	1.0	205	45	5.4	16	120	M6
V	350	105	240	310	1.5	330	70	6.5	30.5	125	M10

All dimensions in mm ; Tolerance according : ISO 2768-C

Connector Cross Sections

	06	16	35	50	95
Wire range	8 to 26 AWG	4 to 20 AWG	2 to 8 AWG	6 to 1/0 AWG	AWG 4/0
Stripping Length	9mm	16mm	19mm	24mm	27mm
Recommended torque (Nm)	1.19 to 1.46	2.48 to 2.82	2.48 to 2.82	4.29 to 4.51	3.5-6